

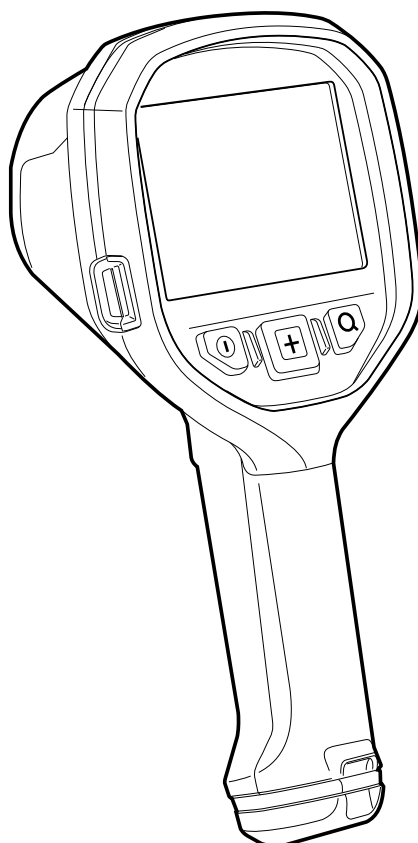

---

# User's manual

## Flir K75 and K85



**Important note**

Before operating the device, you must read, understand, and follow all instructions, warnings, cautions, and legal disclaimers.

**Důležitá poznámka**

Před použitím zařízení si přečtěte veškeré pokyny, upozornění, varování a vyvázání se ze záruky, ujistěte se, že jim rozumíte, a řiďte se jimi.

**Viktig meddelelse**

Før du betjener enheden, skal du læse, forstå og følge alle anvisninger, advarsler, sikkerhedsforanstaltninger og ansvarsfraskrivelser.

**Wichtiger Hinweis**

Bevor Sie das Gerät in Betrieb nehmen, lesen, verstehen und befolgen Sie unbedingt alle Anweisungen, Warnungen, Vorsichtshinweise und Haftungsausschlüsse

**Σημαντική σημείωση**

Πριν από τη λειτουργία της συσκευής, πρέπει να διαβάσετε, να κατανοήσετε και να ακολουθήσετε όλες τις οδηγίες, προειδοποιήσεις, προφυλάξεις και νομικές αποποιήσεις.

**Nota importante**

Antes de usar el dispositivo, debe leer, comprender y seguir toda la información sobre instrucciones, advertencias, precauciones y renuncias de responsabilidad.

**Tärkeä huomautus**

Ennen laitteen käyttämistä on luettava ja ymmärrettävä kaikki ohjeet, vakavat varoitukset, varoitukset ja lakitiedotteet sekä noudatettava niitä.

**Remarque importante**

Avant d'utiliser l'appareil, vous devez lire, comprendre et suivre l'ensemble des instructions, avertissements, mises en garde et clauses légales de non-responsabilité.

**Fontos megjegyzés**

Az eszköz használatá elött figyelmesen olvassa el és tartsa be az összes utasítást, figyelmeztetést, óvintézkedést és jogi nyilatkozatot.

**Nota importante**

Prima di utilizzare il dispositivo, è importante leggere, capire e seguire tutte le istruzioni, avvertenze, precauzioni ed esclusioni di responsabilità legali.

**重要な注意**

デバイスをご使用になる前に、あらゆる指示、警告、注意事項、および免責条項をお読み頂き、その内容を理解して従ってください。

**중요한 참고 사항**

장치를 작동하기 전에 반드시 다음의 사용 설명서와 경고, 주의사항, 법적 책임제한을 읽고 이해하며 따라야 합니다.

**Viktig**

Før du bruker enheten, må du lese, forstå og følge instruksjoner, advarsler og informasjon om ansvarsfraskrivelse.

**Belangrijke opmerking**

Zorg ervoor dat u, voordat u het apparaat gaat gebruiken, alle instructies, waarschuwingen en juridische informatie hebt doorgelezen en begrepen, en dat u deze opvolgt en in acht neemt.

**Ważna uwaga**

Przed rozpoczęciem korzystania z urządzenia należy koniecznie zapoznać się z wszystkimi instrukcjami, ostrzeżeniami, przestrogam i uwagami prawnymi. Należy zawsze postępować zgodnie z zaleceniami tam zawartymi.

**Nota importante**

Antes de utilizar o dispositivo, deverá proceder à leitura e compreensão de todos os avisos, precauções, instruções e isenções de responsabilidade legal e assegurar-se do seu cumprimento.

**Важное примечание**

До того, как пользоваться устройством, вам необходимо прочитать и понять все предупреждения, предостережения и юридические ограничения ответственности и следовать им.

**Viktig information**

Innan du använder enheten måste du läsa, förstå och följa alla anvisningar, varningar, försiktighetsåtgärder och ansvarsfriskrivningar.

**Önemli not**

Cihazı çalıştırmadan önce tüm talimatları, uyarıları, ikazları ve yasal açıklamaları okumalı, anlamalı ve bunlara uymalısınız.

**重要注意事項**

在操作设备之前，您必须阅读、理解并遵循所有说明、警告、注意事项和法律免责声明。

**重要注意事項**

操作裝置之前，您務必閱讀、了解並遵循所有說明、警告、注意事項與法律免責聲明。

# Table of contents

---









<b>1</b>	<b>Safety information</b>	<b>1</b>
1.1	Radio	4
1.2	Label affixed to the camera	5
1.2.1	Flir K75 and Flir K85	5
1.3	Declaration of conformity	5
<b>2</b>	<b>Notice to user</b>	<b>6</b>
2.1	Register your camera	6
2.2	Online documentation	6
2.3	About this manual	6
2.4	Support	6
2.5	Training	6
<b>3</b>	<b>Getting started</b>	<b>7</b>
3.1	Basic steps	7
<b>4</b>	<b>Camera parts and accessories</b>	<b>8</b>
4.1	Camera parts	8
4.2	Accessories	8
4.2.1	Lanyard strap and retractable lanyard	9
4.2.2	Handle strap and retractable lanyard	9
<b>5</b>	<b>Screen elements</b>	<b>10</b>
5.1	Battery condition indicator	11
5.2	Alerts	11
<b>6</b>	<b>Operation</b>	<b>12</b>
6.1	Battery	12
6.1.1	Remove the battery	12
6.1.2	Charge the battery	12
6.2	Regulatory menu	13
6.3	Change the boot up image	13
6.4	Reset to camera factory settings	13
6.5	Camera modes	13
6.5.1	Basic mode	14
6.5.2	Search mode	14
6.5.3	Detection mode	15
6.5.4	High heat mode	15
6.5.5	White hot mode	16
6.6	Take an image	16
6.7	Record a video	16
6.8	Connect the camera to a computer, using the USB cable	17
6.9	View saved images/video clips	18
<b>7</b>	<b>Flir Responder app</b>	<b>20</b>
7.1	Connect the camera to the app	20
7.2	Transfer files	20
7.3	Delete camera files	20
7.4	Configuration	20
7.4.1	Access the configuration	20
7.4.2	Change configuration	20
7.4.3	Saving configurations as preset	20
7.4.4	Apply configurations	20
7.5	Update firmware	21
7.6	Streaming	21
<b>8</b>	<b>In-truck charger (optional accessory)</b>	<b>22</b>
8.1	Introduction	22
8.2	Parts and functions	22
8.3	Choosing a suitable position	23
8.4	Recommended cable area and fuse	23

## Table of contents











---

8.5	Mounting instructions.....	23
8.6	Charging the camera .....	24
8.7	Charging a battery separately.....	24
8.8	Cleaning .....	24
8.9	Customer support .....	24
<b>9</b>	<b>Maintenance and cleaning.....</b>	<b>25</b>
9.1	Calibration.....	25
9.2	Update the Camera .....	25
9.2.1	Update the camera Over-The-Air (OTA).....	25
9.2.2	Update via USB cable with the Flir Camera Updater.....	25
9.3	Clean the camera .....	25
9.3.1	Camera housing, cables, and other items .....	25
9.3.2	Infrared lens.....	26
<b>10</b>	<b>Disposal of electronic waste .....</b>	<b>27</b>
10.1	Battery removal .....	27
<b>11</b>	<b>Disclaimers .....</b>	<b>28</b>
11.1	Legal disclaimer .....	28
11.2	Export controls .....	28
11.3	Patents .....	28
11.4	Quality assurance .....	28
11.5	Third-party licenses.....	28
11.6	Usage statistics .....	28
11.7	Copyright .....	28











# Safety information

	<b>WARNING</b>
<b>Applicability:</b> Cameras with one or more batteries.	
Do not disassemble or do a modification to the battery. The battery contains safety and protection devices which, if damage occurs, can cause the battery to become hot, or cause an explosion or an ignition.	
	<b>WARNING</b>
<b>Applicability:</b> Cameras with one or more batteries.	
If there is a leak from the battery and you get the fluid in your eyes, do not rub your eyes. Flush well with water and immediately get medical care. The battery fluid can cause injury to your eyes if you do not do this.	
	<b>WARNING</b>
<b>Applicability:</b> Cameras with one or more batteries.	
Do not continue to charge the battery if it does not become charged in the specified charging time. If you continue to charge the battery, it can become hot and cause an explosion or ignition. Injury to persons can occur.	
	<b>WARNING</b>
<b>Applicability:</b> Cameras with one or more batteries.	
Only use the correct equipment to remove the electrical power from the battery. If you do not use the correct equipment, you can decrease the performance or the life cycle of the battery. If you do not use the correct equipment, an incorrect flow of current to the battery can occur. This can cause the battery to become hot, or cause an explosion. Injury to persons can occur.	
	<b>WARNING</b>
Make sure that you read all applicable MSDS (Material Safety Data Sheets) and warning labels on containers before you use a liquid. The liquids can be dangerous. Injury to persons can occur.	
	<b>CAUTION</b>
Do not point the infrared camera (with or without the lens cover) at strong energy sources, for example, devices that cause laser radiation, or the sun. This can have an unwanted effect on the accuracy of the camera. It can also cause damage to the detector in the camera.	
	<b>CAUTION</b>
<b>Applicability:</b> Cameras with one or more batteries.	
Do not attach the batteries directly to a car's cigarette lighter socket, unless Flir Systems supplies a specific adapter to connect the batteries to a cigarette lighter socket. Damage to the batteries can occur.	
	<b>CAUTION</b>
<b>Applicability:</b> Cameras with one or more batteries.	
Do not connect the positive terminal and the negative terminal of the battery to each other with a metal object (such as wire). Damage to the batteries can occur.	
	<b>CAUTION</b>
<b>Applicability:</b> Cameras with one or more batteries.	
Do not get water or salt water on the battery, or permit the battery to become wet. Damage to the batteries can occur.	





## Safety information

 <b>CAUTION</b>
<b>Applicability:</b> Cameras with one or more batteries. Do not connect the positive terminal and the negative terminal of the battery to each other with a metal object (such as wire). Damage to the batteries can occur.
 <b>CAUTION</b>
<b>Applicability:</b> Cameras with one or more batteries. Do not make holes in the battery with objects. Damage to the battery can occur.
 <b>CAUTION</b>
<b>Applicability:</b> Cameras with one or more batteries. Do not hit the battery with a hammer. Damage to the battery can occur.
 <b>CAUTION</b>
<b>Applicability:</b> Cameras with one or more batteries. Do not put your foot on the battery, hit it or cause shocks to it. Damage to the battery can occur.
 <b>CAUTION</b>
<b>Applicability:</b> Cameras with one or more batteries. Do not put the batteries in or near a fire, or into direct sunlight. When the battery becomes hot, the built-in safety equipment becomes energized and can stop the battery charging procedure. If the battery becomes hot, damage can occur to the safety equipment and this can cause more heat, damage or ignition of the battery.
 <b>CAUTION</b>
<b>Applicability:</b> Cameras with one or more batteries. Do not put the battery on or near fires, stoves, or other high-temperature locations. Damage to the battery and injury to persons can occur.
 <b>CAUTION</b>
<b>Applicability:</b> Cameras with one or more batteries. Do not solder directly onto the battery. Damage to the battery can occur.
 <b>CAUTION</b>
<b>Applicability:</b> Cameras with one or more batteries. Do not use the battery if, when you use, charge, or put the battery in storage, there is an unusual smell from the battery, the battery feels hot, changes color, changes shape, or is in an unusual condition. Speak with your sales office if one or more of these problems occurs. Damage to the battery and injury to persons can occur.
 <b>CAUTION</b>
<b>Applicability:</b> Cameras with one or more batteries. Only use a specified battery charger when you charge the battery. Damage to the battery can occur if you do not do this.
 <b>CAUTION</b>
<b>Applicability:</b> Cameras with one or more batteries. Only use a specified battery for the camera. Damage to the camera and the battery can occur if you do not do this.

## Safety information



 <b>CAUTION</b>
<p><b>Applicability:</b> Cameras with one or more batteries.</p> <p>The temperature range through which you can charge the battery is 0°C to +45°C (+32°F to +113°F). If you charge the battery at temperatures out of this range, it can cause the battery to become hot or to break. It can also decrease the performance or the life cycle of the battery.</p>
 <b>CAUTION</b>
<p><b>Applicability:</b> Cameras with one or more batteries.</p> <p>The temperature range through which you can remove the electrical power from the battery is -15°C to +50°C (+5°F to +122°F), unless other information is specified in the user documentation or technical data. If you operate the battery out of this temperature range, it can decrease the performance or the life cycle of the battery.</p>
 <b>CAUTION</b>
<p><b>Applicability:</b> Cameras with one or more batteries.</p> <p>When the battery is worn, apply insulation to the terminals with adhesive tape or equivalent materials before you discard it. Damage to the battery and injury to persons can occur if you do not do this.</p>
 <b>CAUTION</b>
<p><b>Applicability:</b> Cameras with one or more batteries.</p> <p>Remove any water or moisture on the battery before you install it. Damage to the battery can occur if you do not do this.</p>
 <b>CAUTION</b>
<p>Do not apply solvents or equivalent liquids to the camera, the cables, or other items. Damage to the battery and injury to persons can occur.</p>
 <b>CAUTION</b>
<p>Be careful when you clean the infrared lens. The lens has an anti-reflective coating which is easily damaged. Damage to the infrared lens can occur.</p>
 <b>CAUTION</b>
<p>Do not use too much force to clean the infrared lens. This can cause damage to the anti-reflective coating.</p>
 <b>CAUTION</b>
<p>Do not change the standard fire-fighting procedures when you use a Flir K series camera. The Flir K series camera is not a replacement technology.</p>
 <b>CAUTION</b>
<p>Do not use the Flir K series camera without the correct training. If the persons that operate the camera do not have the correct training, an incorrect analysis of the infrared images can occur. Thus, incorrect decisions during the firefighting can be made.</p> <p>The training must include:</p> <ul style="list-style-type: none"> <li>• How a thermal camera operates and its limits</li> <li>• How to interpret an image</li> <li>• How to work safely with the camera.</li> </ul>
 <b>CAUTION</b>
<p>Make sure that you do not use a torque value that is more than 80 Ncm on the Torx T20 screw. Damage to the camera can occur if you do not obey this.</p>





## Safety information

 <b>CAUTION</b>
Only use the equipment as given in the applicable manufacturer's instructions. If you do not obey this, the protection that the equipment gives can become unsatisfactory. Damage to the equipment can occur.
 <b>CAUTION</b>
Only use with batteries that have the part number T300815 or T199368 on them (that Flir Systems AB supplies). Damage to the equipment can occur if you do not obey this.
 <b>WARNING</b>
Make sure that you only change the batteries in a known safe area. If you do not obey this, an explosion can occur. An explosion can cause death or injury to persons and damage to the equipment.
 <b>CAUTION</b>
Do not open unless you are sure that there are no flammable materials in the area. A fire or an explosion can occur. This can cause injury or death to persons and damage to the equipment.
 <b>CAUTION</b>
Do not use the connection port while it is in a classified (danger) area. Injury to persons and damage to the equipment can occur.

**Note** The encapsulation rating is only applicable when all the openings on the camera are sealed with their correct covers, hatches, or caps. This includes the compartments for data storage, batteries, and connectors.

## 1.1 Radio

 <b>WARNING</b>
<b>Applicability:</b> Class B digital devices. This equipment has been tested and found to comply with the limits for a Class B digital device, pursuant to Part 15 of the FCC Rules. These limits are designed to provide reasonable protection against harmful interference in a residential installation. This equipment generates, uses and can radiate radio frequency energy and, if not installed and used in accordance with the instructions, may cause harmful interference to radio communications. However, there is no guarantee that interference will not occur in a particular installation. If this equipment does cause harmful interference to radio or television reception, which can be determined by turning the equipment off and on, the user is encouraged to try to correct the interference by one or more of the following measures: <ul style="list-style-type: none"> <li>• Reorient or relocate the receiving antenna.</li> <li>• Increase the separation between the equipment and receiver.</li> <li>• Connect the equipment into an outlet on a circuit different from that to which the receiver is connected.</li> <li>• Consult the dealer or an experienced radio/TV technician for help.</li> </ul>
 <b>WARNING</b>
<b>Applicability:</b> Digital devices subject to 15.19/RSS-GEN. <b>NOTICE:</b> This device complies with Part 15 of the FCC Rules and with Industry Canada licence-exempt RSS standard(s). Operation is subject to the following two conditions: <ol style="list-style-type: none"> <li>1. this device may not cause harmful interference, and</li> <li>2. this device must accept any interference received, including interference that may cause undesired operation.</li> </ol>
 <b>WARNING</b>
<b>Applicability:</b> Digital devices subject to 15.21. <b>NOTICE:</b> Changes or modifications made to this equipment not expressly approved by FLIR Systems may void the FCC authorization to operate this equipment.

	<b>WARNING</b>
<p><b>Applicability:</b> Digital devices subject to 2.1091/2.1093/KDB 447498/RSS-102.</p> <p><b>Radiofrequency radiation exposure Information:</b> For body worn operation, this device has been tested touched to the phantom and meets FCC RF exposure guidelines. Nevertheless, the device should be used in such a manner that the potential for human contact during normal operation is minimized.</p>	
	<b>WARNING</b>
<p>This device is granted pursuant to the Japanese Radio Law (電波法) and the Japanese Telecommunications Business Law (電気通信事業法). This device should not be modified (otherwise the granted designation number will become invalid)</p>	
	<b>WARNING</b>
<p>Do not disassemble or do a modification to the battery. The battery contains safety and protection devices which, if damage occurs, can cause the battery to become hot, or cause an explosion or an ignition.</p>	
	<b>WARNING</b>
<p>Make sure that you read all applicable MSDS (Material Safety Data Sheets) and warning labels on containers before you use a liquid. The liquids can be dangerous. Injury to persons can occur.</p>	
	<b>CAUTION</b>
<p>Do not point the infrared camera (with or without the lens cover) at strong energy sources, for example, devices that cause laser radiation, or the sun. This can have an unwanted effect on the accuracy of the camera. It can also cause damage to the detector in the camera.</p>	

## 1.2 Label affixed to the camera

### 1.2.1 Flir K75 and Flir K85

**FLIR K-Series**  
Thermal Imaging Camera  
Model: FLIR-K1870

## 1.3 Declaration of conformity

The full text of the Declaration of conformity is available at the following internet address:  
<http://support.flir.com/resources/v362>.

## 2.1 Register your camera

Register your camera within 60 days to receive an extended warranty and other related benefits.

To register the camera, go to [www.flir.com/register](http://www.flir.com/register).

To access the registration form, you must log in to your Flir account or sign up for a new account.

You will also need the serial number of your camera. The serial number is displayed by the registration wizard in the camera and can later be found in the top bar of the camera menu and in the app.

## 2.2 Online documentation

Our manuals are continuously updated and published online.

To access the Flir Kxx series user manual and other product documentation, go to <http://support.flir.com/resources/v362>.

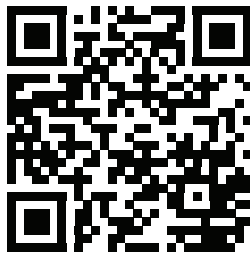

To access the manuals for our other products, as well as manuals for our discontinued products, go to <https://support.flir.com/resources/app>.

## 2.3 About this manual

Flir Systems issues generic manuals that cover several models within a camera series. This means that this manual may contain descriptions and explanations that do not apply to your particular camera model.

The authoritative version of this publication is English. In the event of divergences due to translation errors, the English text has precedence. Any late changes are first implemented in English.

## 2.4 Support

Contact our Technical Support Center if you experience problems or have any questions about your product: <https://support.flir.com>.

## 2.5 Training

For training resources and courses, go to <https://www.flir.com/support-center/training>.

**Note** Before operating the camera, you must read, understand, and follow the warnings and cautions in section 1 *Safety information*.

## 3.1 Basic steps

1. Charge the battery for 4 hours before starting the camera for the first time, or until the blue battery condition LED glows continuously.
2. Push the battery into the camera battery compartment.
3. Press the *Power* button to power on the camera.
4. Follow the instructions on the camera screen to set up the camera according to your preferences.

**Note** Select the settings as part of the camera's initial setup or later at any time via the Flir Responder app.

5. To measure a temperature, aim the camera toward the object. Make sure the spotmeter is on the point of interest. The spotmeter temperature is displayed on the screen.
6. To save an image, pull the trigger (by default, to make changes to the configuration see section 7.4 *Configuration*).

## 4.1 Camera parts

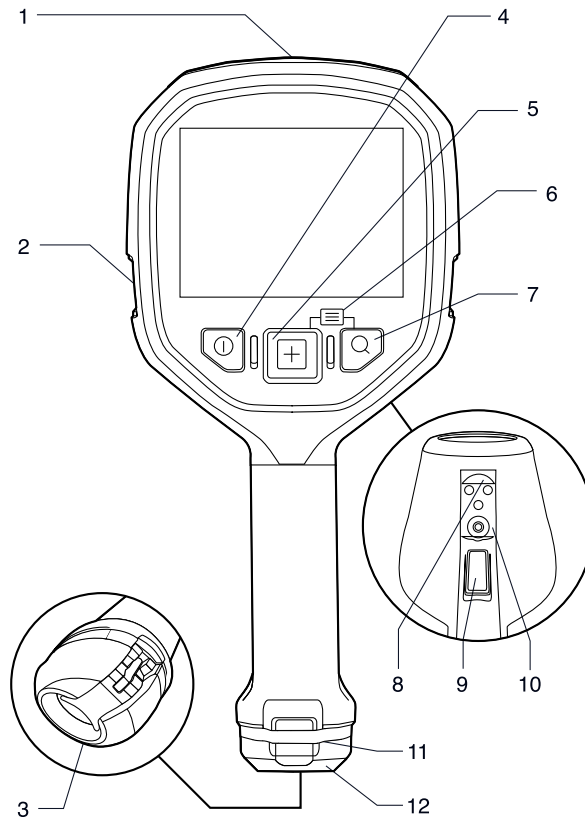

1. USB-C connector.
2. Attachment point for the lanyard strap/neck strap (left and right sides).
3. Eccentric latch to secure the battery.
4. Power button. This button has three functions:
  - Press the *Power* button to turn on the camera.
  - When the camera is on, short press returns the camera to basic mode. Long press sets the camera to standby mode, camera turns off after 6 hours.
  - Press and hold the *Power* button for more than 10 seconds to turn off the camera.
5. Mode button: Press repeatedly to select camera modes.
6. Mode + Zoom button: Access to menu, with connectivity settings, gallery, regulatory and camera information menu.
7. Zoom button (zoom factor 2x).
8. Connector for in-truck charger.
9. Trigger.
10. Mount for tripod adapter.
11. Attachment point for the retractable lanyard.
12. Battery.

## 4.2 Accessories

See the Flir K75 and K85 product page on [www.flir.com](http://www.flir.com) for available accessories and services.

1. USB-C cable
2. Neck strap
3. Lanyard

4. Battery charger, incl. power supply with multi plugs
5. Li-Ion battery pack 3.6 V 16 Wh
6. Retractable lanyard

#### 4.2.1 Lanyard strap and retractable lanyard

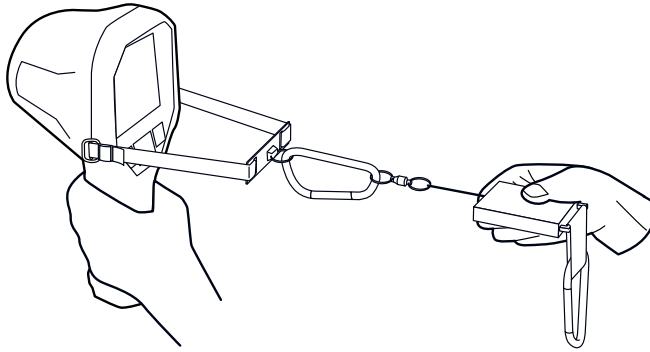

#### 4.2.2 Handle strap and retractable lanyard

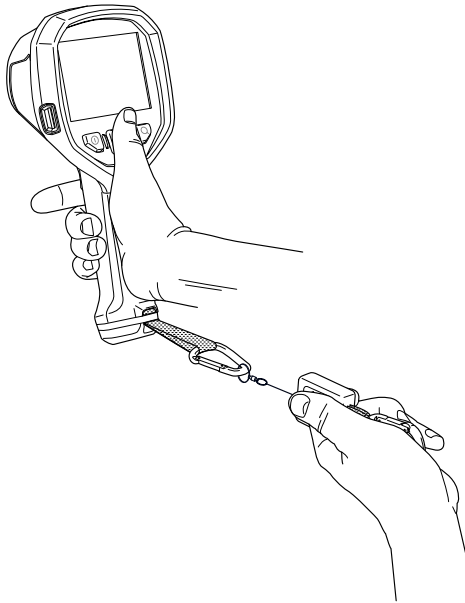

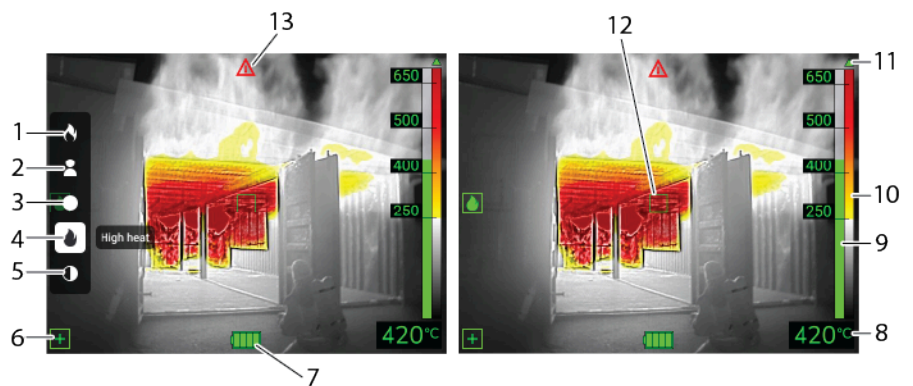





1. Basic mode. Main mode for firefighting and smoke diving.
2. Search mode. Tactical mode before, during and after fire with earlier colorization.
3. Detection mode. Includes hot and cold spot trackers and highlights significantly hotter areas in a red gradient.
4. High heat mode. Similar to Basic mode but with a higher temperature starting.
5. White hot mode. No colorization, to preserve detail in the black and white image.
6. TI Basic plus indicator shows that the camera is in TI Basic plus mode.
7. Battery condition indicator.
8. Center spot temperature read out.
9. Temperature bar.
10. Heat color reference bar.
11. Change in the color reference indicator symbol. When a new mode is selected, a change in the color temperature reference triangle appears above the reference bar. The triangle remains visible for 1 second.
12. Center spot.
13. Overheating indicator. The indicator provides a visual warning to the user that the thermal imager is about to shut down due to internal overheating.

#### Note

- Working in camera modes other than Basic mode may require additional training.

## 5.1 Battery condition indicator

Icon	Explanation
	76–100% power.
	51–75% power.
	26–50% power.
	<25% power. The battery symbol starts flashing when there is at least 5 minutes of battery life left.

## 5.2 Alerts



When a red triangle appears on the screen, the camera is overheated. This indicates that the camera is at risk of turning off if it is not cooled down.

**CAUTION**

Do not use the Flir K series camera without the correct training. If the persons that operate the camera do not have the correct training, an incorrect analysis of the infrared images can occur. Thus, incorrect decisions during the firefighting can be made.

The training must include:

- How a thermal camera operates and its limits
- How to interpret an image
- How to work safely with the camera.

## 6.1 Battery

### 6.1.1 Remove the battery

1. Pull the eccentric latch.



2. Pull out the battery from the battery compartment.

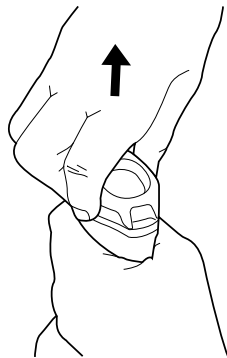

### 6.1.2 Charge the battery

**WARNING**

Make sure that you install the socket-outlet near the equipment and that it is easy to get access to.

Charge the battery for 4 hours before starting the camera for the first time, or until the blue battery condition LED glows continuously.

1. Put the battery in the standalone battery charger.
2. Connect the power supply cable plug to the connector on the standalone battery charger.
3. Connect the power supply mains-electricity plug to a mains socket.

4. Disconnect the power supply cable plug when the blue battery condition LED glows continuously.

## 6.2 Regulatory menu

To get to the regulatory menu, do the following:

1. Press the *Mode* and *Zoom* buttons at the same time.
2. Use the *Mode* button to go down in the menu.
3. Select *Regulatory*.

## 6.3 Change the boot up image

To change the logo in the menu:

1. Make sure the camera is connected to the Flir Responder app.
2. Go to *Boot image*.
3. Select *Change image*.
4. Select to attach an image or select *Take photo*.

## 6.4 Reset to camera factory settings

**Note** No files are deleted when restoring to factory settings.

1. Open the main menu.
2. Go to *Camera information*.
3. Select *Reset camera*.

The factory reset will trigger onboarding to reopen.

## 6.5 Camera modes

Press the *Mode* button to select camera mode.

The camera modes for Flir K75 and Flir K85 cameras are:

1. Basic mode.
2. Search mode.
3. Detection mode.
4. High heat mode.
5. White hot mode.

### 6.5.1 Basic mode

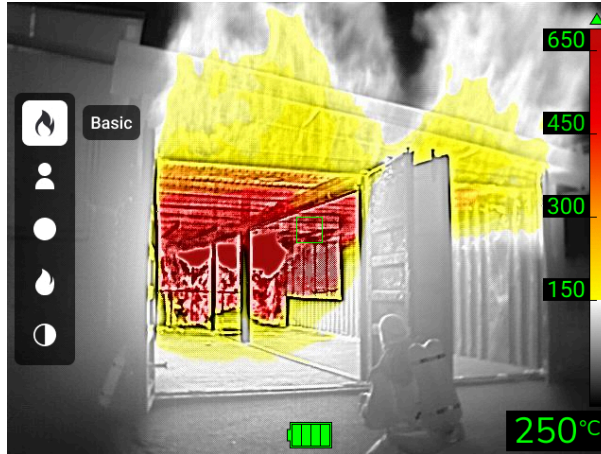

Figure 6.1 Basic mode.

*Basic mode* is the main mode for firefighting and smoke diving.

- Colorization of heat begins at 150°C/300°F and transitions to 650°C/1200°F.

### 6.5.2 Search mode

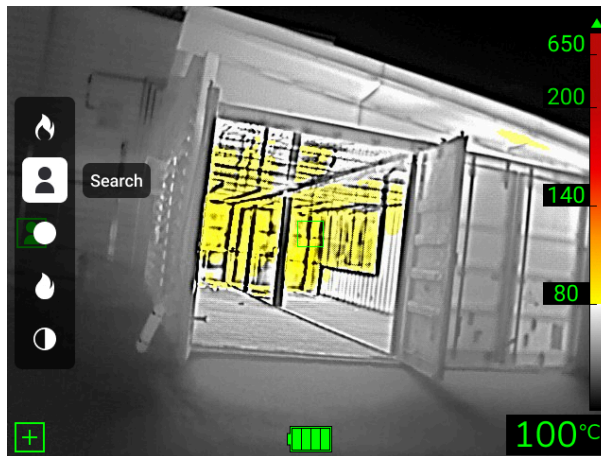

Figure 6.2 Search mode.

*Search mode* is a tactical mode before, during and after fire with earlier colorization.

- Colorization begins at 80°C/175°F and transitions to 200°C/390°F.

### 6.5.3 Detection mode

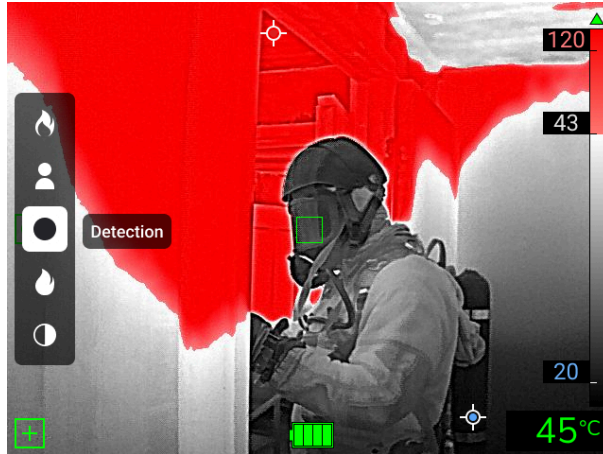

Figure 6.3 Detection mode.

*Detection mode* includes hot and cold spot trackers and highlights significantly hotter areas in a red gradient.

### 6.5.4 High heat mode

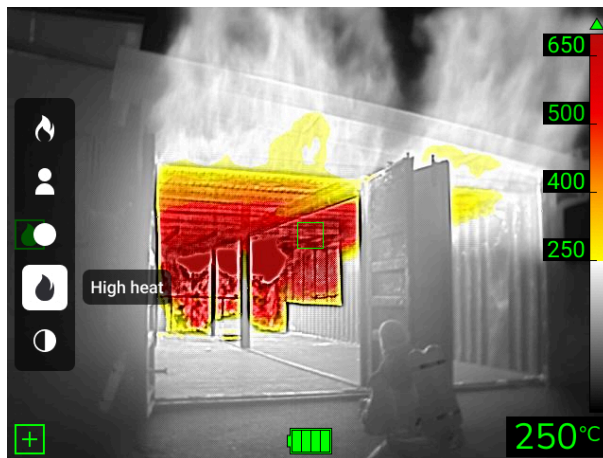

Figure 6.4 High heat mode.

*High heat mode* is similar to Basic mode but with a higher temperature starting point.

- Colorization begins at 250°C/480°F and transitions to 650°C/1200°F.

### 6.5.5 White hot mode



Figure 6.5 White hot mode

*White hot mode* displays no colorization to preserve detail in the black and white image.

## 6.6 Take an image

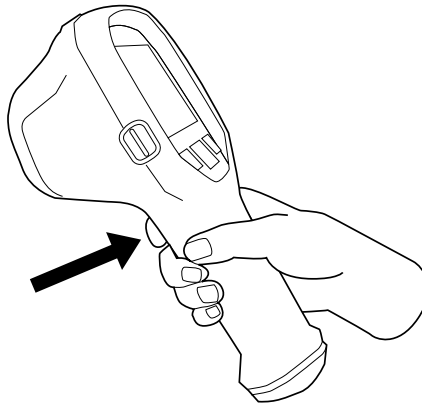

1. Aim the camera toward an object of interest.
2. A short press on the *Trigger* will take an image.
3. The image will be automatically saved in the camera's archive.

## 6.7 Record a video

**Note** The *Trigger* button can be configured in the Flir Responder app.

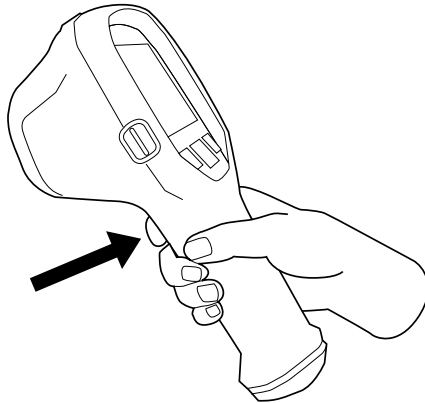

1. Point the camera at the object.
2. Hold the *Trigger* for a couple of seconds.
3. A red circle on the screen indicates that the camera is currently recording a video clip.
4. To stop recording do a short press on the *Trigger*.

## 6.8 Connect the camera to a computer, using the USB cable

1. Fold up the rubber cover at the top of the camera.

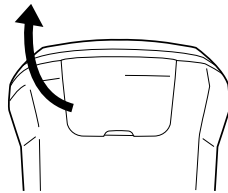

2. Hold the metal ring firmly.

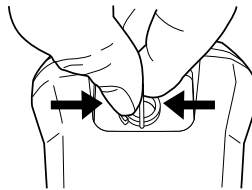

3. Rotate the ring about 90° counter-clockwise.

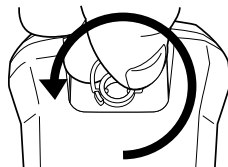

- Pull out the plastic insert.

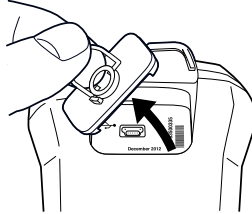
**CAUTION**

The plastic insert has an O-ring seal. Do not damage the O-ring seal.

- Connect the USB cable to the USB-C connector in the connector bay.

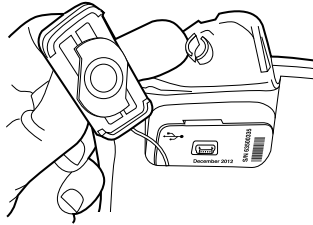

- Move the images to the computer using a drag-and-drop operation.

**Note** Moving an image using a drag-and-drop operation does not delete the image in the camera.

## 6.9 View saved images/video clips

To view saved images or video clips, do the following:

- Press the *Mode* and *Zoom* buttons at the same time. This displays the main menu.

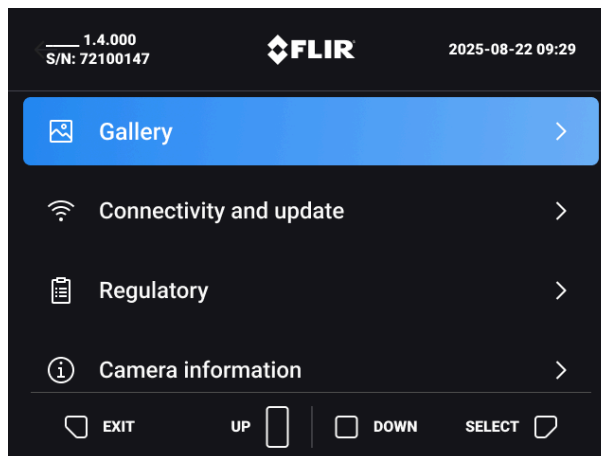

2. Select *Gallery*.

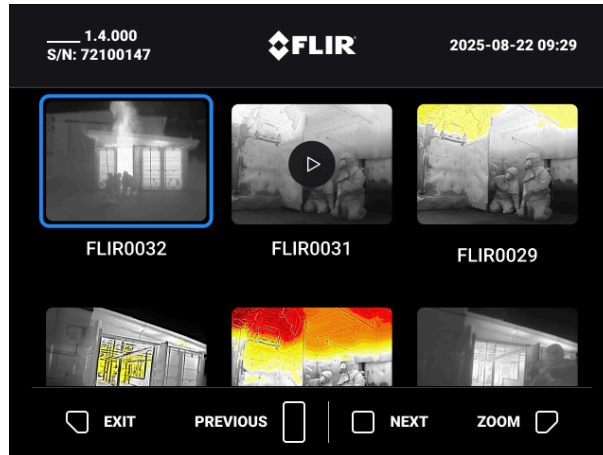

3. Select *PREVIOUS* or *NEXT* to navigate in the gallery.
4. Select *EXIT* to exit the gallery.

Flir Responder is the app for the K75 and K85 cameras. With Flir Responder it is possible to wirelessly configure the camera, update firmware, manage images/videos, and live stream. To download the app, visit App Store or Google play.

## 7.1 Connect the camera to the app

1. Make sure the app is installed on the mobile device.
2. Press the *Power* button to start the camera.
3. Make sure the Wi-Fi connectivity switch is turned on. Find it in the camera menu *Connectivity and update*.
4. Place the camera close to the mobile device.
5. Start the Flir Responder app on the mobile device.
6. The Flir Responder app guides you how to connect the camera with the mobile device. The Wi-Fi connectivity must be turned on to be able to see it in the app.

## 7.2 Transfer files

Preview, transfer and delete files from the camera via the app.

1. Open the Flir Responder app on the mobile device.
2. Go to *Files*.
3. Preview and select images to share to other apps.

## 7.3 Delete camera files

1. Open the Flir Responder app on the mobile device.
2. Make sure the camera is connected and go to *Files*.
3. Select which files to delete or delete all.

**Note** Deleting files through the app will permanently delete them from the camera.

## 7.4 Configuration

Use the Flir Responder app to configure the camera.

### 7.4.1 Access the configuration

1. Make sure the camera is connected to the app.
2. Open the app.
3. Select *Configuration*.

### 7.4.2 Change configuration

- Change mode.
- Applicable trigger behavior/continuous recording.
- Settings such as temperature unit, date and time configurations and center spot settings (applies to all modes).

Settings that differ from the current camera configuration are shown in blue.

### 7.4.3 Saving configurations as preset

- Any configuration can be saved as a preset.
- A saved preset can be used multiple times and applied to other cameras.

### 7.4.4 Apply configurations

1. Toggle *Allow camera updates* in the camera's *Connectivity and update* menu.

2. Keep the *Connectivity and update* menu open.  
This is for security reasons to prevent configuration changes from being sent during the mission.
3. After the changes are done in the app, select *Send to camera*.

## 7.5 Update firmware

A notification in the Flir Responder app will show when a new firmware update is available.

To update the firmware:

1. Make sure the camera is connected to the app.
2. Turn on *Allow camera update* in the camera's connectivity menu.
3. Select *Camera information*.
4. Select *Install* to install the available update.

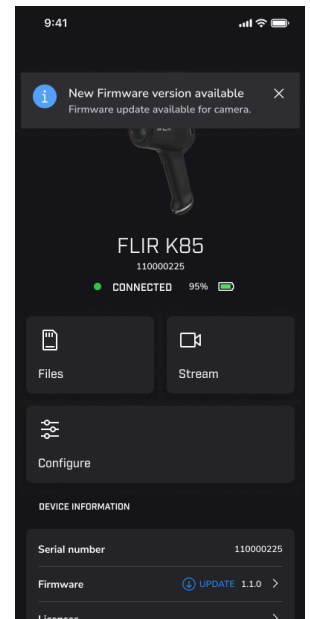

## 7.6 Streaming

Stream from the camera and the camera will be mirrored in the app.

1. Connect the camera to the app.
2. Go to the *Streaming* section.
3. The camera view is automatically mirrored in the app.

# In-truck charger (optional accessory)

## 8.1 Introduction



Thank you for choosing the Flir K75 and K85 series in-truck charger from Flir Systems.

The in-truck charger is intended to be mounted on a flat surface in the cab, in one of the equipment lockers, or in another suitable compartment on the fire engine. The in-truck charger has five ports for cable routing—one through the rear of the metal bracket and one port on each side of the in-truck charger.

The in-truck charger can also be powered using a standard Flir Systems power supply, and has a battery charger located at the lower front of the unit.

## 8.2 Parts and functions

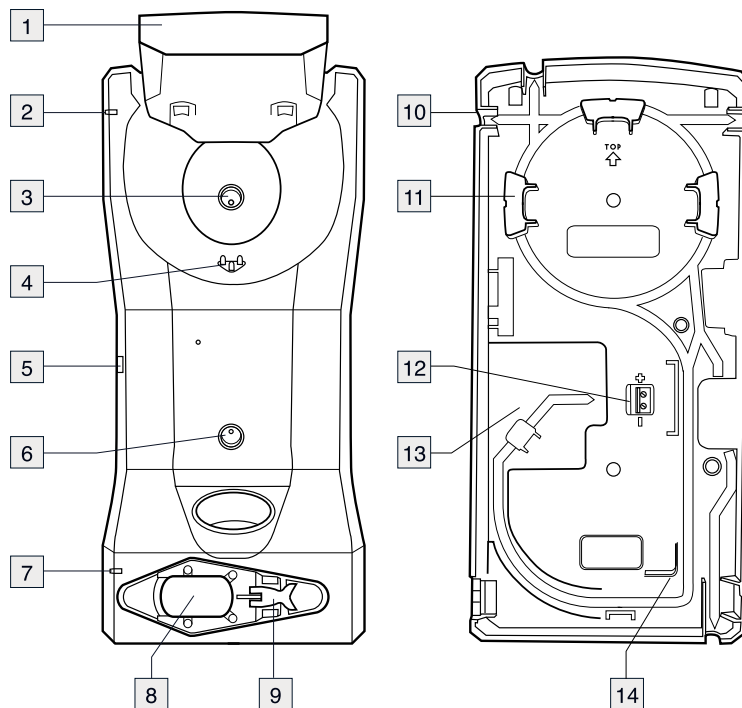

1. Top cover.
2. LED indicator for the camera charger.

- 
3. Hole for attaching the charger housing to the metal bracket.
  4. Connectors in the cradle.
  5. Connector to power the charger using a standard Flir Systems power supply.
  6. Hole for attaching the charger housing to the metal bracket.
  7. LED indicator for the battery charger.
  8. Battery slot.
  9. Eccentric latch to secure the battery during charging.
  10. Cable port (1 of 4).

**Note** There is also one port through the rear of the metal bracket.

11. Routing support.
12. 12–24 VDC cable plinth.
13. Recess for the cable.
14. Routing support.

### 8.3 Choosing a suitable position

Before mounting the in-truck charger, take a few minutes to think about a suitable position.

The mounting position should be protected from rain and road splash, and it should be reasonably easy to install a permanent cable running from the fire engine's 12–24 VDC system to the in-truck charger.

Additional considerations may be important, e.g., getting access to panels and equipment behind the in-truck charger.

### 8.4 Recommended cable area and fuse

Cable area	1.5 mm <sup>2</sup> (No. 15 AWG)
Fuse	5 A

### 8.5 Mounting instructions

Follow this procedure:

1. Permanently install a cable running from the fire engine's 12–24 VDC system to the selected mounting position of the in-truck charger. Do not connect this cable to the 12–24 VDC system at this time. The routing must include a fuse installed close to the battery. See above for the fuse recommendation.
2. Remove the two screws that hold the metal bracket.
3. Remove the metal bracket.
4. Use the metal bracket as a template to mark where the mounting holes should be drilled.
5. Drill the holes.
6. Mount the metal bracket using the rivets and/or screws that come with the in-truck charger.
7. Connect the cable to the cable plinth on the rear of the in-truck charger.
 

**Note** Take note of the polarity when you connect the cable to the cable plinth.
8. Route the cable so that it exits through the cable port of your choice.
9. Mount the in-truck charger to the metal bracket using the two screws that you removed in Step 2 above.
10. Permanently connect the cable to the fire engine's 12–24 VDC system.

## 8.6 Charging the camera

Follow this procedure:

1. Pull up the top cover of the in-truck charger.
2. Push the camera into position.
3. Push down the top cover.

The charging of the camera has now started, and is finished when the blue light glows continuously. Charging a fully depleted camera takes approximately 4 hours.

## 8.7 Charging a battery separately

Flir K75 and K85 series batteries can be charged separately using the battery charger at the lower front of the unit.

Follow this procedure:

1. Pull the eccentric latch on the bottom of the camera.
2. Pull out the battery from the camera.
3. Push the battery into the slot at the lower front of the charger.
4. Secure the battery using the eccentric latch on the charger.

The charging of the battery has now started, and is finished when the blue light glows continuously. Charging a fully depleted battery takes approximately 4 hours.

## 8.8 Cleaning



### CAUTION

Disconnect the in-truck charger from the fire engine's 12–24 VDC system before cleaning.

The in-truck charger can be cleaned using warm water or a weak detergent solution. Do not use solvents or similar liquids.

## 8.9 Customer support

Should you experience any problems, do not hesitate to contact our Customer Support at <http://support.flir.com>.

## 9.1 Calibration

We recommend that you send in the camera for calibration once a year. Contact your local sales office or contact our Technical Support Center at <https://www.flir.com/support> for instructions on where to send the camera.

## 9.2 Update the Camera

To take advantage of our latest camera firmware, it is important that you keep your camera updated.

There are several ways to update the camera:

- To update through the app, a notification will show in the app or go to *Camera information* > *Firmware version* to see available updates.
- Connect the camera to a computer with a USB cable and use the Flir Camera Updater application to update the camera.
- Download an update package and update the camera manually. For more information, go to <https://support.flir.com>.

### 9.2.1 Update the camera Over-The-Air (OTA)

**Note** When a new firmware version is available, there will be a notification in the Flir Responder app.

To install a new firmware version, do the following:

1. Make sure the camera battery is fully charged.
2. Make sure the camera has Wi-Fi enabled and to toggle on the *Allow camera updates*.
3. Select *Settings* > *Update*.
4. If an update is available, select *Download* to download the installation package.
5. Select *Install* to start the installation.
6. When the installation is completed, the camera will automatically restart.

### 9.2.2 Update via USB cable with the Flir Camera Updater

To update your camera, you must log in to your Flir account or sign up for a new account. You must also register the camera.

#### 9.2.2.1 Install the Flir Camera Updater

1. Go to <https://support.flir.com>. Find the software download area and search for Flir Camera Updater.
2. Download the Flir Camera Updater installer package.
3. Start the installation by double-clicking the executable installer file.
4. Follow the instructions in the setup wizard.

## 9.3 Clean the camera

### 9.3.1 Camera housing, cables, and other items

Use one of these liquids:

- Warm water
- A weak detergent solution

Equipment:

- A soft cloth

Follow this procedure:

1. Soak the cloth in the liquid.

2. Twist the cloth to remove excess liquid.
3. Clean the part with the cloth.

**CAUTION**

Do not apply solvents or similar liquids to the camera, the cables, or other items. This can cause damage.

**9.3.2 Infrared lens**

Use one of these liquids:

- A commercial lens cleaning liquid with more than 30% isopropyl alcohol.
- 96% ethyl alcohol (C<sub>2</sub>H<sub>5</sub>OH).

Equipment:

- Cotton wool

**CAUTION**

If you use a lens cleaning cloth it must be dry. Do not use a lens cleaning cloth with the liquids that are listed above. These liquids can cause material on the lens cleaning cloth to become loose. This material can have an unwanted effect on the surface of the lens.

Follow this procedure:

1. Soak the cotton wool in the liquid.
2. Twist the cotton wool to remove excess liquid.
3. Clean the lens one time only and discard the cotton wool.

**WARNING**

Make sure that you read all applicable MSDS (Material Safety Data Sheets) and warning labels on containers before you use a liquid: the liquids can be dangerous.

**CAUTION**

- Be careful when you clean the infrared lens. The lens has a delicate anti-reflective coating.
- Do not clean the infrared lens too vigorously. This can damage the anti-reflective coating.

Waste of Electrical and Electronic Equipment (WEEE) poses a risk to human health and the environment when not disposed of properly. This product should not be discarded as unsorted waste but must be sent to separate collection facilities for recovery and recycling. More information is available from the relevant local authority.



## 10.1 Battery removal

Before disposal of the camera, remove the battery.

Before you discard the battery, apply insulation to the terminals with adhesive tape or equivalent materials.

## 11.1 Legal disclaimer

For warranty terms, refer to <https://www.flir.com/warranty>.

## 11.2 Export controls

Products described herein may be subject to export regulations.

This document does not contain export-controlled information.

## 11.3 Patents

This product is protected by patents, design patents, patents pending, or design patents pending. Refer to the FLIR Systems' patent registry:

<https://www.flir.com/patentnotices>

## 11.4 Quality assurance

The Quality Management System under which these products are developed and manufactured has been certified in accordance with the ISO 9001 standard.

FLIR Systems is committed to a policy of continuous development; therefore we reserve the right to make changes and improvements on any of the products without prior notice.

## 11.5 Third-party licenses

Information about third-party licenses is available in the user interface of the product.

## 11.6 Usage statistics

FLIR Systems reserves the right to gather anonymous usage statistics to help maintain and improve the quality of our software and services.

## 11.7 Copyright

© 2025 FLIR Systems, Inc. All rights reserved worldwide. No parts of the software including source code may be reproduced, transmitted, transcribed or translated into any language or computer language in any form or by any means, electronic, magnetic, optical, manual or otherwise, without the prior written permission of FLIR Systems.

The documentation must not, in whole or part, be copied, photocopied, reproduced, translated or transmitted to any electronic medium or machine readable form without prior consent, in writing, from FLIR Systems.

Names and marks appearing on the products herein are either registered trademarks or trademarks of FLIR Systems and/or its subsidiaries. All other trademarks, trade names or company names referenced herein are used for identification only and are the property of their respective owners.



---

**Website**  
<http://www.flir.com>

**Customer support**  
<http://support.flir.com>

**Copyright**  
© 2025, FLIR Systems, Inc. All rights reserved worldwide.

**Disclaimer**  
Specifications subject to change without further notice. Models and accessories subject to regional market considerations. License procedures may apply. Products described herein may be subject to US Export Regulations. Please refer to [exportquestions@flir.com](mailto:exportquestions@flir.com) with any questions.

Publ. No.: T559946  
Release: AA  
Commit: 107443  
Head: 107443  
Language: en-US  
Modified: 2025-09-01  
Formatted: 2025-09-01